

Built
Bull
Dog
Tuff™



**Bull
Dog
Power
Products®**

WARNER®

LED POWER TOWERS™

POWER TOWERS™ LED

POWER TOWERS™ DEL

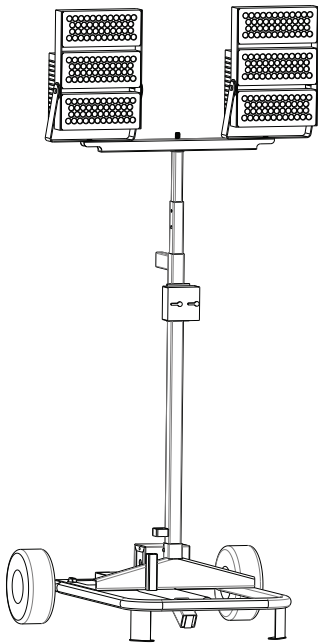

Model numbers: P11300, P11600

Números de modelo: P11300, P11600

Numéros de modèle : P11300, P11600

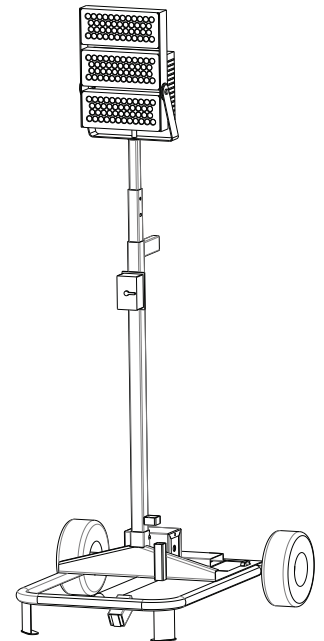

Read all instructions carefully before operating or servicing this light.

Lea atentamente las instrucciones antes de usar o dar mantenimiento a esta lámpara.

Lire ces instructions avec soin avant toute opération de mise en marche et de réparation.



When using outdoor portable luminaires, basic safety precautions should always be followed to reduce the risk of fire, electric shock and personal injury or death.

READ ALL INSTRUCTIONS! The user must read and understand all instructions and labels before using this product. Failure to follow these instructions may cause severe injury or death.

SAVE THESE INSTRUCTIONS

SAFETY INSTRUCTIONS

- 1. Ground Fault Circuit Interrupter (GFCI) is to be provided on the circuit(s) or outlet(s) to be used for the wet location portable luminaire. Receptacles are available having built-in GFCI protection and are able to be used for this measure of safety.*
- 2. Keep light at least 16 feet from pools, ponds or standing water.*
- 3. Do not use extension cords near water or where water may accumulate.*
- 4. Use only three-wire outdoor extension cords that have three-prong grounding plugs and grounding receptacles that accept the appliance's plug. Use only outdoor extension cords of cord type: SEW, SEOW, SE00W, SOW, SOOW, STW, STOW, STOOW, SJEW, SJEOW, SJE00W, SJW, SJOW, SJOOW, SJTW, SJTOW or SJTOOW.*
- 5. To prevent fire or explosions keep fixture away from all flammable materials.*
- 6. Never look directly into the light to avoid eye injuries.*
- 7. The metal mast and housing conduct electricity. Use extreme caution to avoid contact with overhead electrical wiring.*
- 8. Use extreme caution when raising and lowering the light heads. Failure to control the mast may cause the light head to fall rapidly and injure the user.*
- 9. Examine the unit before each use. Never use this light if it is damaged or bare wires are exposed.*
- 10. Use only Bull Dog replacement parts to repair this unit.*

For safety concerns, repair information or replacement parts, contact Bull Dog Customer Service at 1-800-444-0606 or customerservice@warnertool.com.

ASSEMBLY OF POWER TOWER MODELS P11300 AND P11600:

1. Place cart on a level surface.
2. Insert mast in mast holder on cart and tighten mast locking knob.
3. Insert fixture mount into inner mast and insert safety snap pin through holes.
4. Route power cord through cord retaining ring near base of mast.

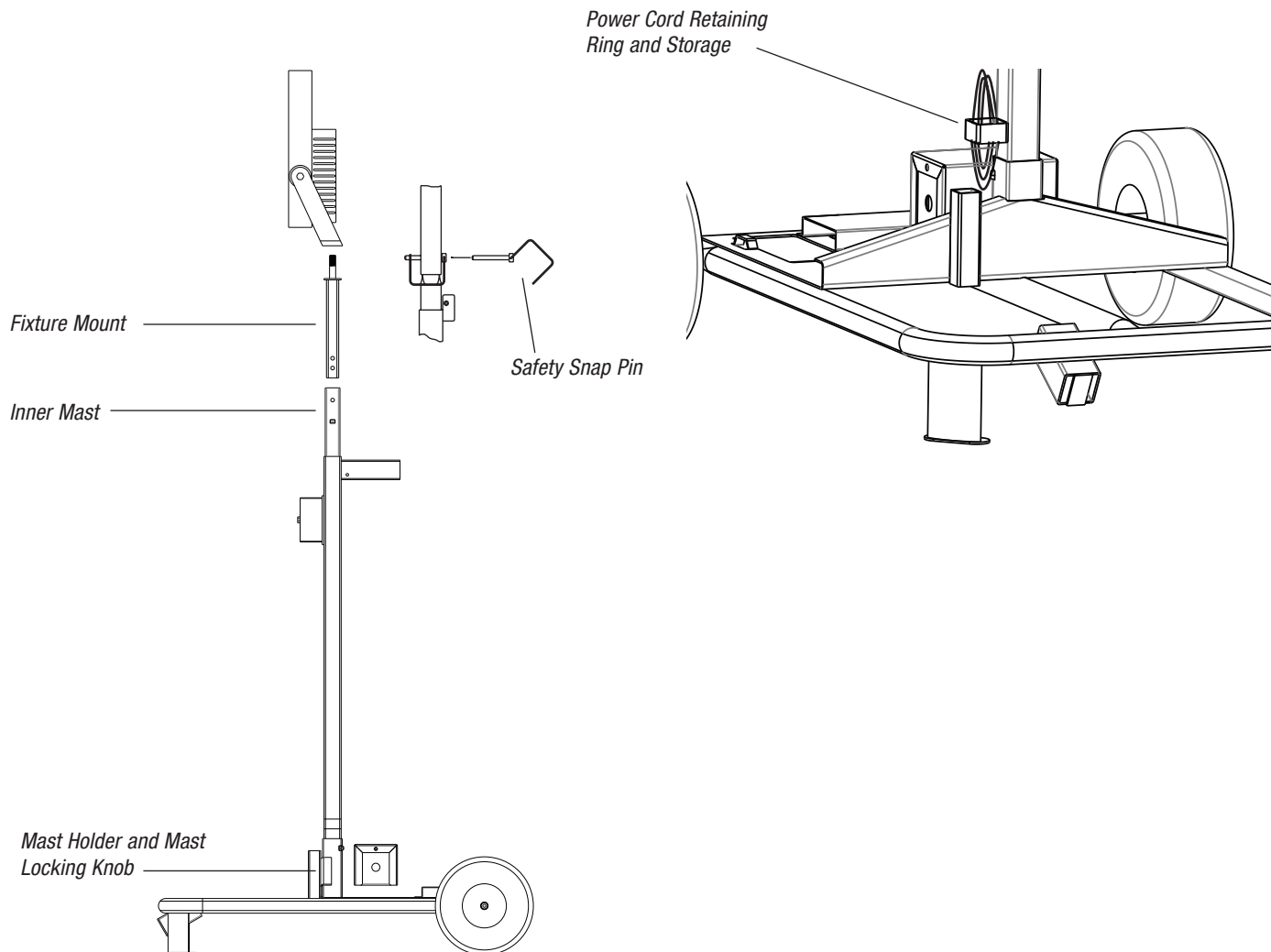

OPERATING INSTRUCTIONS:

1. Place the light base on a flat stable surface and set the wheel brake.
2. Use sandbags or anchors to stabilize the unit for outdoor applications.
3. Make sure the cord is properly attached to the base of the light to prevent a trip hazard.
4. Plug the light into a properly grounded circuit. Use a GFCI protected circuit for outdoor use.
5. Adjust the light head fixture to desired angles.
6. Carefully extend the light heads to the maximum height. Be aware of overhead power lines. Use caution to control the mast to prevent the mast from dropping and injuring the user. Make sure the mast lock tab is in place.
7. Turn on the switch that is mounted on the lower mast section.







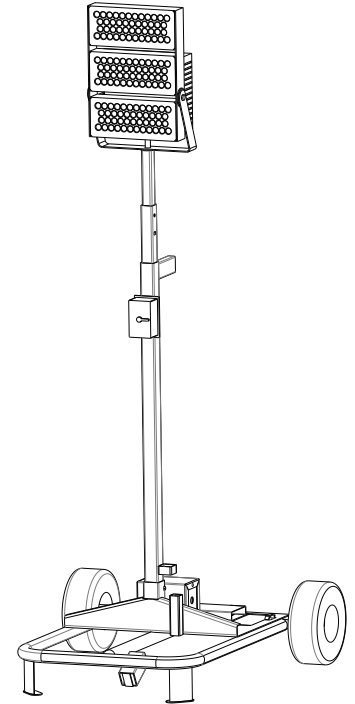
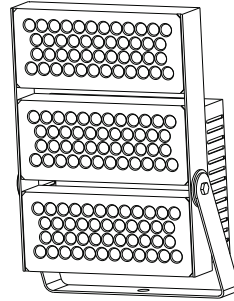



P11300 REPLACEMENT PARTS

P104670 LED Fixture with Mounting Bracket



Mast Set P103606

-  P103600 Top Mast
-  P103597 Base Mast
-  P33440 Washer
-  6545 1/4-20 Nut
-  P103232 1/4-20 x 1-1/2 Bolt
-  P44006P Trigger
-  P46050 End Cap Mast Handles
-  P44003 1" x 1-1/2" Tubing

P103615 Single Junction Box

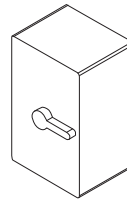

P103616 Single Switch Cover

P103593 Base

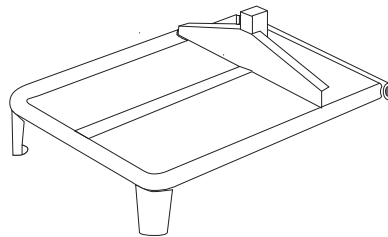

P103618 7.5 Ft. Power Cord



P101157 Snap Pin

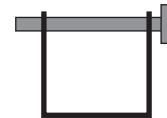





P40003 Wheel





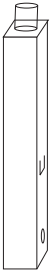



P46052 3/8 Knob



Fixture Mount

-  P103602 Pivot Mount
-  P100551 Washer
-  P101121 Washer
-  P104667 Trigger
-  P100545 Washer

Brake Parts P100436

-  P100488 Short Brake Bar
-  P100487 Long Brake Bar
-  P41000 Brake T-Bar
-  P46056 1/4" Washer
-  P40054 5/16-18 Nut
-  P33441 3/4" Washer Nylon
-  P40051 5/16-18 x 1" Screw

All Screws, Bolts, Nuts and Washers are standard sizes



P11600 REPLACEMENT PARTS

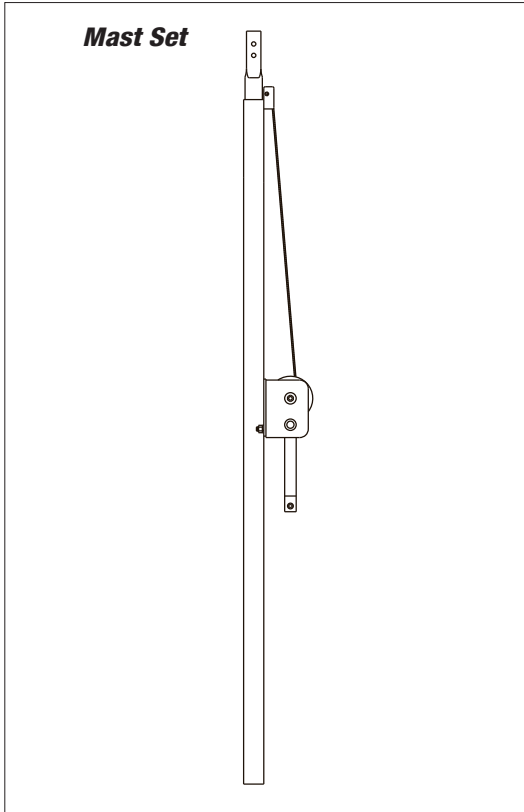

P104670 LED Fixture with Mounting Bracket

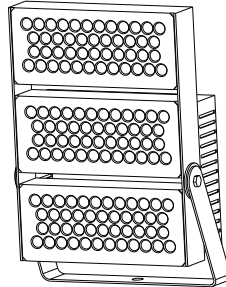

P103769 Double Junction Box

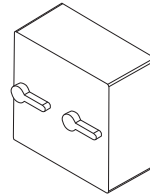

P103770 Double Switch Cover

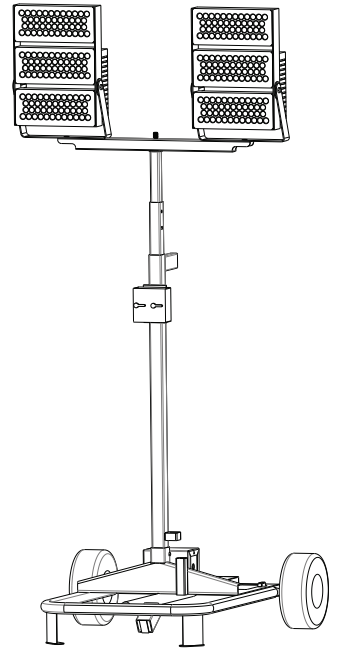

P103618 7.5 Ft. Power Cord



P103593 Base

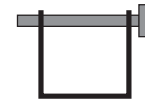
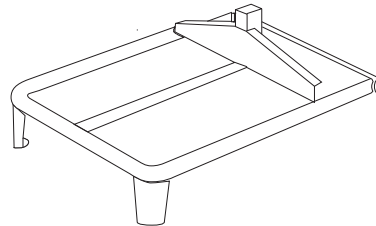

P101157 Snap Pin

P46052 3/8 Knob



P40003 Wheel



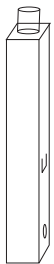
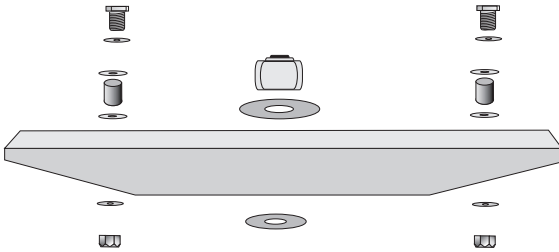



Double Light Head Cross Bar Assembly P100512



P103602 Pivot Mount

-  P100551
-  P101121
-  P104667
-  P100545
-  P100550

Brake Parts P100436

-  P100488 Short Brake Bar
-  P100487 Long Brake Bar
-  P41000 Brake T-Bar
-  P46056 1/4" Washer
-  P40054 5/16-18 Nut
-  P33441 3/4" Washer Nylon
-  P40051 5/16-18 x 1" Screw

All Screws, Bolts, Nuts and Washers are standard sizes

P11300 SINGLE HEAD LED LIGHT TOWER JUNCTION BOX WIRING

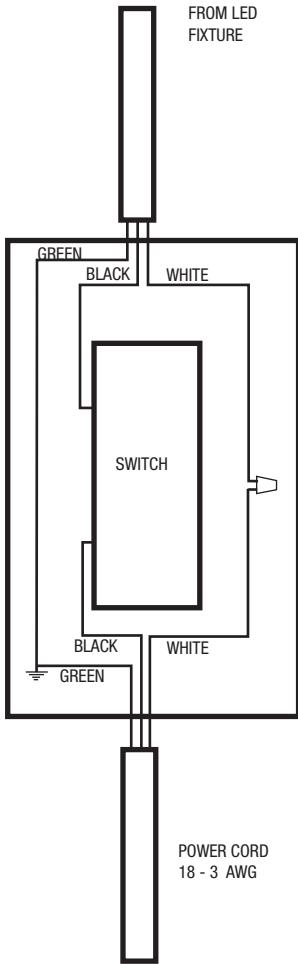

P11600 DOUBLE HEAD LED LIGHT TOWER JUNCTION BOX WIRING

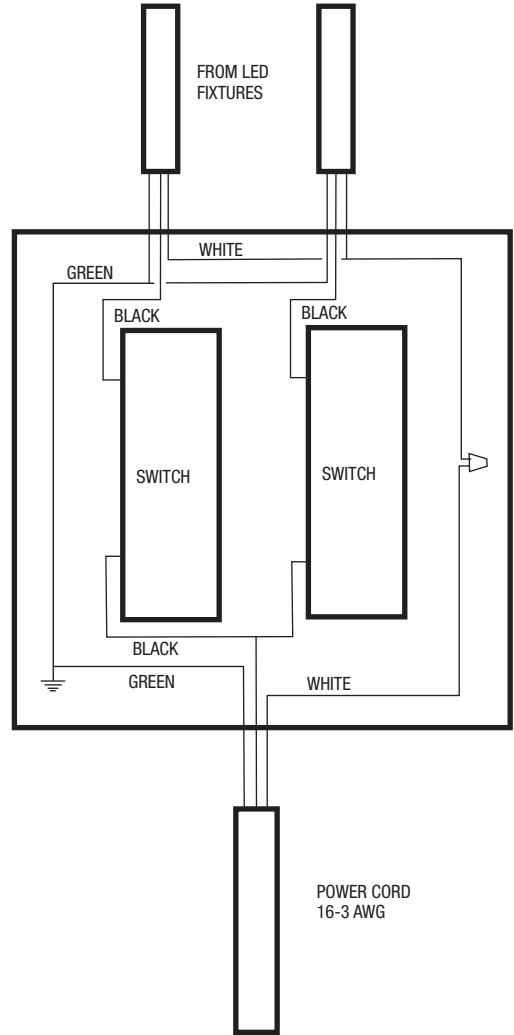

JUNCTION BOX WITH TIP-OVER SWITCH WIRING

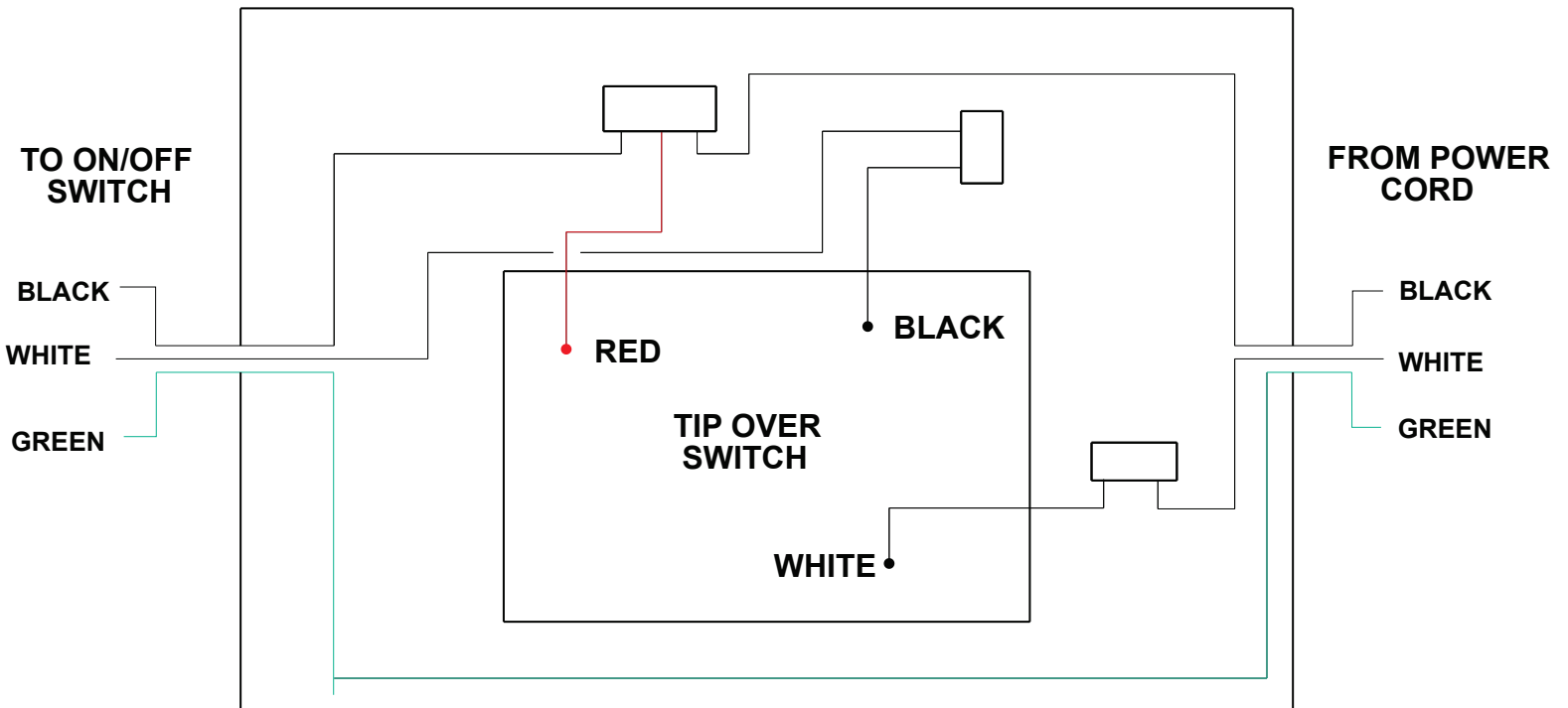



Cuando utilice luminarias portátiles en exteriores, siempre se deben observar las precauciones básicas de seguridad para disminuir el riesgo de incendio, descarga eléctrica y lesiones personales o la muerte.

¡LEA TODAS LAS INSTRUCCIONES! El usuario deberá leer y comprender todas las instrucciones y etiquetas fijadas antes de utilizar este producto. La inobservancia de estas instrucciones puede ocasionar lesiones graves o la muerte.

GUARDE ESTAS INSTRUCCIONES

Instrucciones de seguridad:

- 1. El interruptor de circuito por falla de conexión a tierra (Ground Fault Circuit Interrupter, GFCI) se debe proporcionar en el(los) circuito(s) o tomacorriente(s) que se va(n) a utilizar en el lugar húmedo donde se colocará la luminaria portátil. Los receptáculos están disponibles con protección GFCI incorporada y se pueden utilizar para esta medida de seguridad.*
- 2. Conserve la lámpara a por lo menos 16 pies (4.9 m) de piscinas, estanques o agua estancada.*
- 3. No utilice con cable de extensión cerca del agua o donde esta pueda acumularse.*
- 4. Utilice solo cables de extensión de tres cables para exteriores con tres clavijas de conexión a tierra, y receptáculos de conexión a tierra que acepten el conector del producto. Utilice solo con cables de extensión para exteriores de los tipos de cable: SEW, SEOW, SE00W, SOW, SOOW, STW, STOW, STOOW, SJEW, SJEOW, SJE00W, SJW, SJOW, SJOOW, SJTW, SJTOW o SJTOOW.*
- 5. Para prevenir incendio o explosiones conserve el accesorio de iluminación alejado de todos los materiales inflamables.*
- 6. Nunca mire directamente a la luz para evitar lesiones oculares.*
- 7. El mástil de metal y la carcasa son conductores de electricidad. Tenga precaución extrema para evitar el contacto con el cableado eléctrico elevado.*
- 8. Tenga precaución extrema cuando eleve y baje los cabezales de la lámpara. La falta de control del mástil puede ocasionar que el cabezal de la lámpara caiga rápidamente y lesione al usuario.*
- 9. Examine la unidad antes de cada uso. Nunca utilice esta lámpara si está dañada o los cables pelados están expuestos.*
- 10. Utilice solo piezas de repuesto Bull Dog para reparar esta unidad.*

Para las inquietudes sobre seguridad, la información sobre reparación o las piezas de repuesto, comuníquese con el Servicio al cliente de Bull Dog llamando al 1-800-444-0606 o customerservice@warnertool.com.

ENSAMBLE DE LOS MODELOS POWER TOWER P11300 Y P11600:

1. Coloque la base transportadora en una superficie nivelada.
2. Inserte el mástil en el soporte de la base transportadora y apriete la perilla de fijación del mástil.
3. Inserte el soporte del accesorio de iluminación en el mástil interno e inserte la clavija a presión de seguridad a través de los agujeros.
4. Inserte el cable de alimentación a través del aro de retención del cable cerca de la base del mástil.

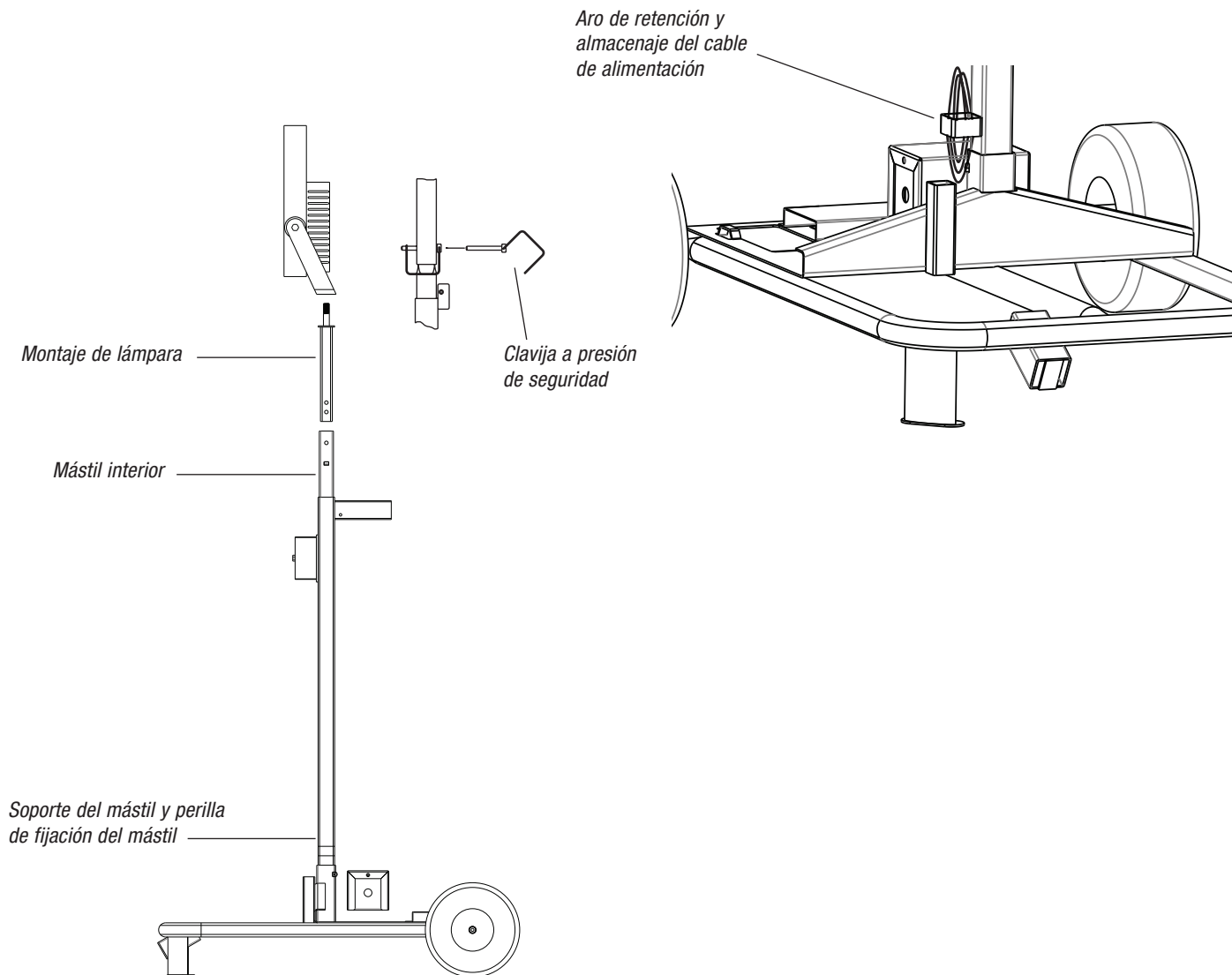

INSTRUCCIONES DE EMPLEO:







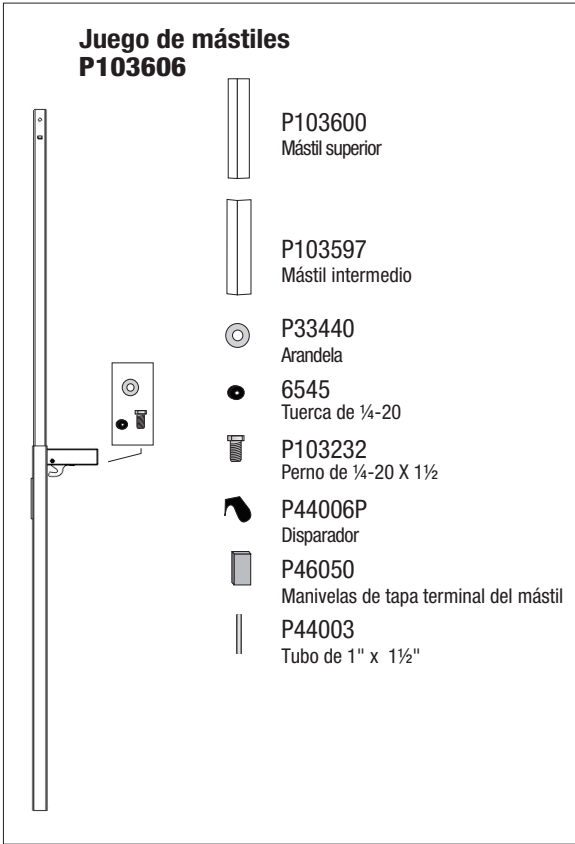

1. Coloque la base de la lámpara en una superficie plana estable y fije el freno de la rueda.
2. Utilice bolsas de arena o anclajes para estabilizar la unidad en aplicaciones de exteriores.
3. Compruebe que el cable esté adecuadamente fijado a la base de la lámpara para evitar el riesgo de tropezar.
4. Enchufe la lámpara en un circuito adecuadamente conectado a tierra. Utilice un circuito con protección GFCI para uso en exteriores.
5. Ajuste el accesorio del cabezal de la lámpara a los ángulos deseados.
6. Extienda los cabezales de la lámpara cuidadosamente a su máxima altura. Esté atento al cableado eléctrico elevado. Tenga precaución al controlar el mástil para evitar que caiga y lesione al usuario. Verifique que la pestaña de fijación del mástil esté en su lugar.
7. Active el interruptor que está montado en la sección inferior del mástil.



P11300 PIEZAS DE REPUESTO

Juego de mástiles P103606



-  P103600
Mástil superior
-  P103597
Mástil intermedio
-  P33440
Arandela
-  6545
Tuerca de 1/4-20
-  P103232
Perno de 1/4-20 X 1 1/2
-  P44006P
Disparador
-  P46050
Manivelas de tapa terminal del mástil
-  P44003
Tubo de 1" x 1 1/2"

P104670 Accesorio de iluminación
LED con soportes de montaje

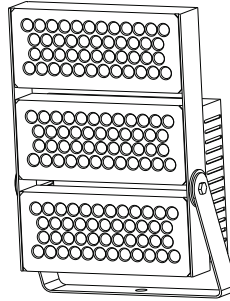

P103615 Cajetín
de empalme sencillo

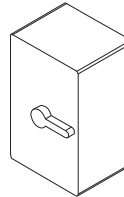

P103616 Tapa de
interruptor sencillo

P103593 Base

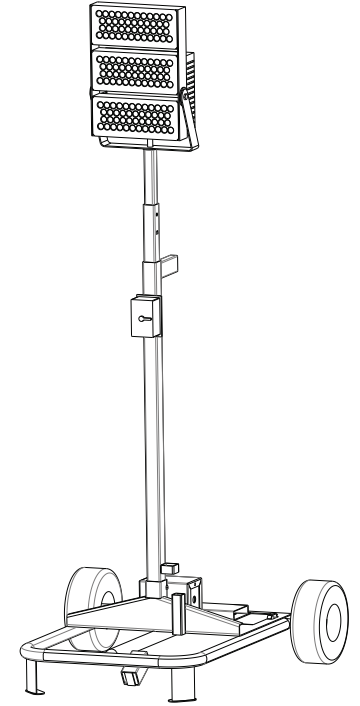
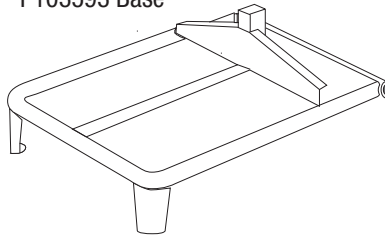

P103618
Cable de alimentación
de 7.5 ft (2.3 m)



P101157
Clavija a presión



P40003
Rueda







P46052
Manivela de 3/8

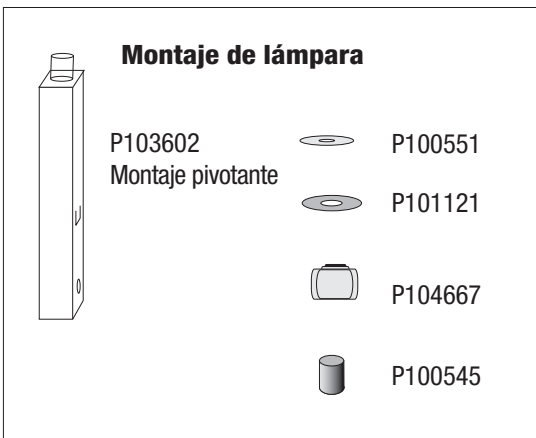







Montaje de lámpara



-  P103602
Montaje pivotante
-  P100551
-  P101121
-  P104667
-  P100545

Piezas de freno P100436

-  P100488
Barra de freno corta
-  P100487
Barra de freno larga
-  P41000
Barra en T de freno
-  P46056
Arandela de 1/4"
-  P40054
Tuercas de 5/16-18
-  P33441
Arandela de nylon de 3/4"
-  P40051
Tornillos de 5/16-18 x 1"

Todos los tornillos, pernos, tuercas y arandelas son de tamaño estándar.



P11600 PIEZAS DE REPUESTO

Juego de mástiles

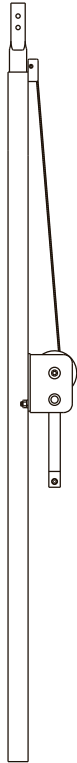

P104670 Accesorio de iluminación LED con soportes de montaje

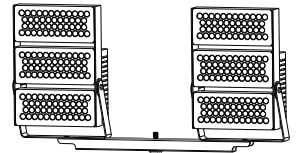
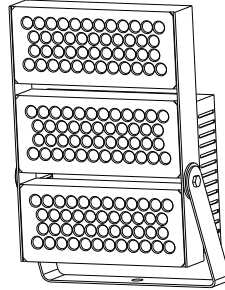

P103769 Cajetín de empalme doble

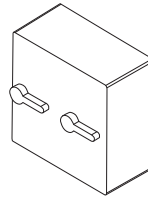

P103770 Tapa de interruptor doble

P103618
Cable de alimentación de 7.5 ft (2.3 m)



Ensamblaje de barra transversal de cabezal de iluminación doble P100512

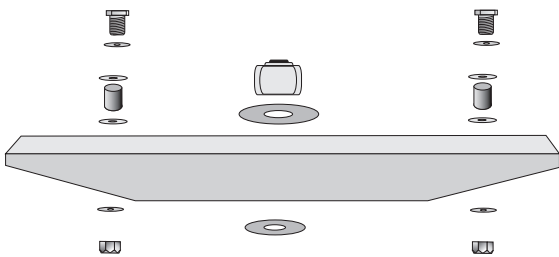

P103593 Base

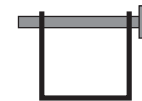
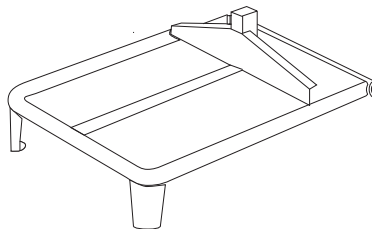







P101157
Clavija a presión

P46052
Manivela de 3/8



P40003
Rueda

Piezas de freno P100436

- | | | | |
|---|---------------------------------|---|--------------------------------------|
|  | P100488
Barra de freno corta |  | P46056
Arandela de 1/4" |
|  | P100487
Barra de freno larga |  | P40054
Tuercas de 5/16-18 |
|  | P41000
Barra en T de freno |  | P33441
Arandela de nailon de 3/4" |
| | |  | P40051
Tornillos de 5/16-18 x 1" |

P103602
Montaje pivotante



- | | |
|---|---------|
|  | P100551 |
|  | P101121 |
|  | P104667 |
|  | P100545 |
|  | P100550 |

Todos los tornillos, pernos, tuercas y arandelas son de tamaño estándar.

P11300 CABLEADO DEL CAJETÍN DE EMPALMES DE LA TORRE DE ILUMINACIÓN LED DE CABEZAL SENCILLO

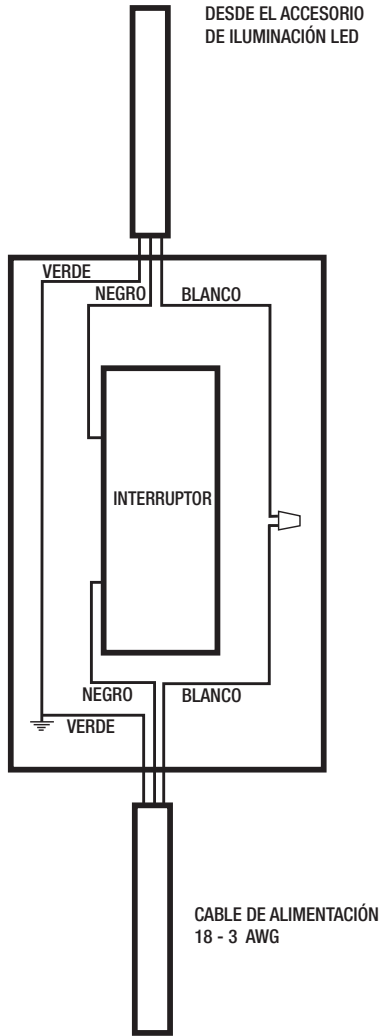

P11600 CABLEADO DEL CAJETÍN DE EMPALMES DE LA TORRE DE ILUMINACIÓN LED DE CABEZAL DOBLE

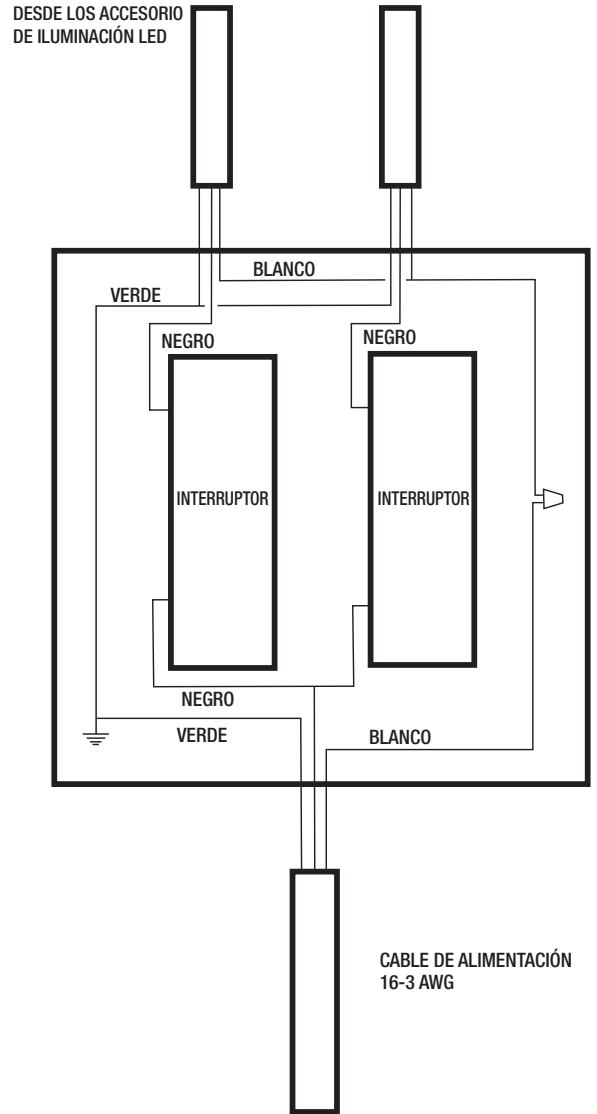

CAJA DE CONEXIONES CON CABLEADO DE INTERRUPTOR DE VUELTA

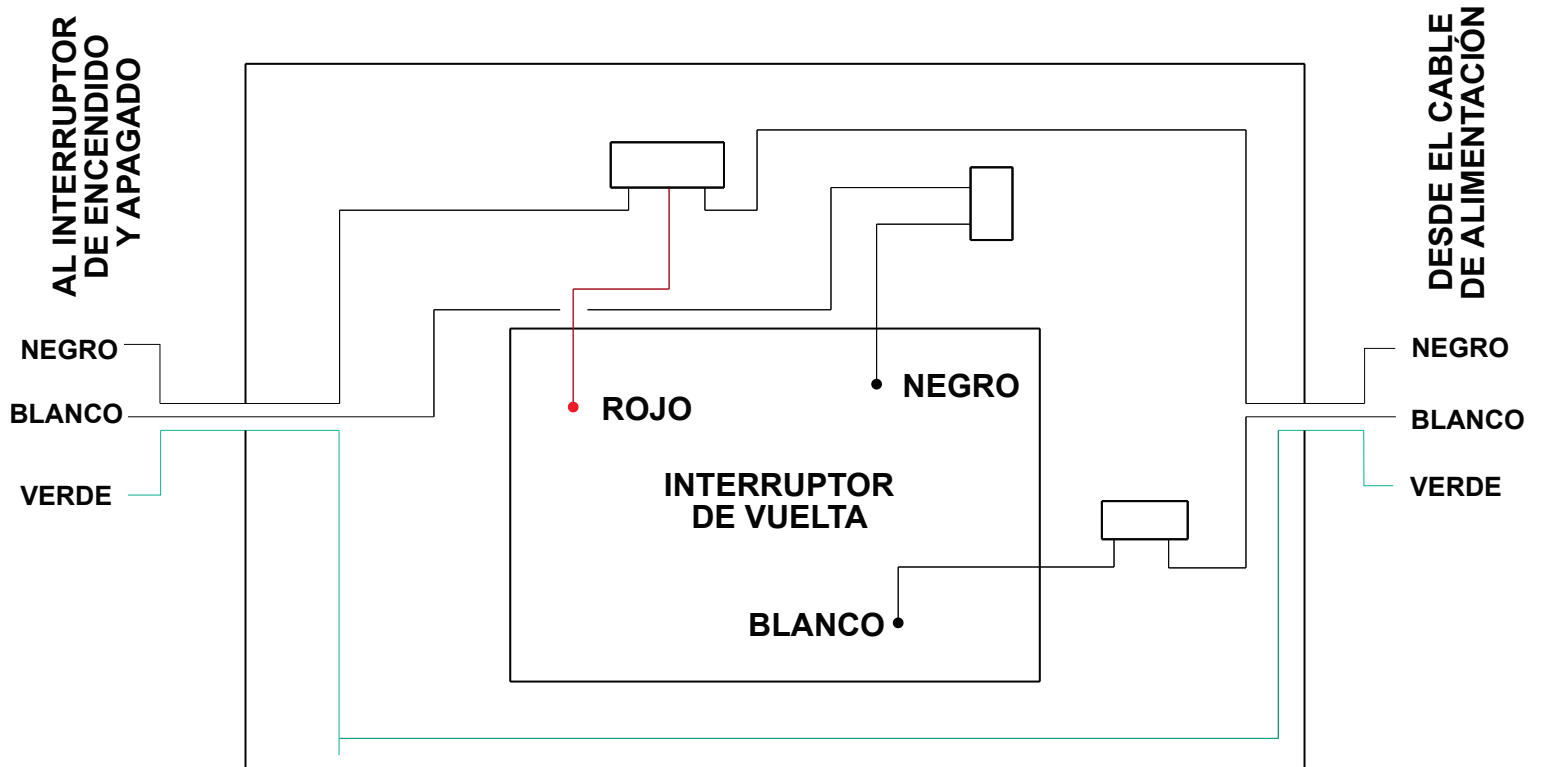



AVERTISSEMENT :

Lors de l'utilisation de luminaires portables extérieurs, des précautions de sécurité de base doivent toujours être respectées afin de réduire les risques d'incendie, d'électrocution, de blessure ou de mort.

LIRE TOUTES LES INSTRUCTIONS ! L'utilisateur doit lire et comprendre toutes les instructions et les étiquettes avant d'utiliser ce produit. Le non-respect de ces instructions peut entraîner des blessures graves ou la mort.

CONSERVEZ CES INSTRUCTIONS

Instructions de sécurité :

1. Un disjoncteur de fuite de terre (GFCI) doit être fourni sur le(s) circuit(s) où la(les) prise(s) utilisé(s) pour le luminaire portable à emplacement humide. Les boîtiers sont dotés d'une protection GFCI intégrée et peuvent être utilisés pour cette mesure de sécurité.
2. Tenir la lampe à au moins 4,9 m (16 pi) à l'écart des piscines, étangs ou d'eau stagnante.
3. Ne pas utiliser de rallonge près de l'eau ou dans un endroit où l'eau peut s'accumuler.
4. Utiliser uniquement des rallonges extérieures à trois fils munies de prises de mise à la terre à trois broches et de boîtiers avec mise à la terre acceptant la prise de l'appareil. Utiliser uniquement des rallonges extérieures de type : SEW, SEOW, SEOWW, SOW, SOOW, STW, STOW, STOOW, SJEW, SJEOW, SJEOWW, SJW, SJOW, SJOOW, SJTW, SJTOW ou SJTOOW.
5. Pour éviter les incendies ou les explosions, éloigner tout matériel inflammable.
6. Pour éviter les blessures aux yeux, ne jamais regarder directement dans la lumière.
7. Le mât et le boîtier en métal conduisent l'électricité. Être extrêmement prudent afin d'éviter tout contact avec le câblage électrique en hauteur.
8. Être extrêmement prudent en élevant et en abaissant les têtes d'éclairage. Si on ne contrôle pas le mât, la tête de la lampe risque de tomber rapidement et de blesser l'utilisateur.
9. Examiner l'appareil avant chaque utilisation. Ne jamais utiliser cette lampe si elle est endommagée ou si des fils nus sont exposés.
10. Utiliser uniquement des pièces de rechange Bull Dog pour réparer cet appareil.

Pour des questions de sécurité, de réparation ou de pièces de rechange, contacter le service à la clientèle Bull Dog au 1-800-444-0606 ou customerservice@warnertool.com.

ASSEMBLAGE DES MODÈLES POWER TOWER P11300 ET P11600 :

1. Placez le socle roulant sur une surface de niveau.
2. Insérez le mât dans le porte-mât situé sur la plateforme roulante et serrez le bouton de verrouillage du mât.
3. Insérez la lampe dans le mât intérieur et insérez la goupille de sécurité dans les trous.
4. Acheminez le cordon d'alimentation à travers la bague de retenue du cordon près de la base du mât.

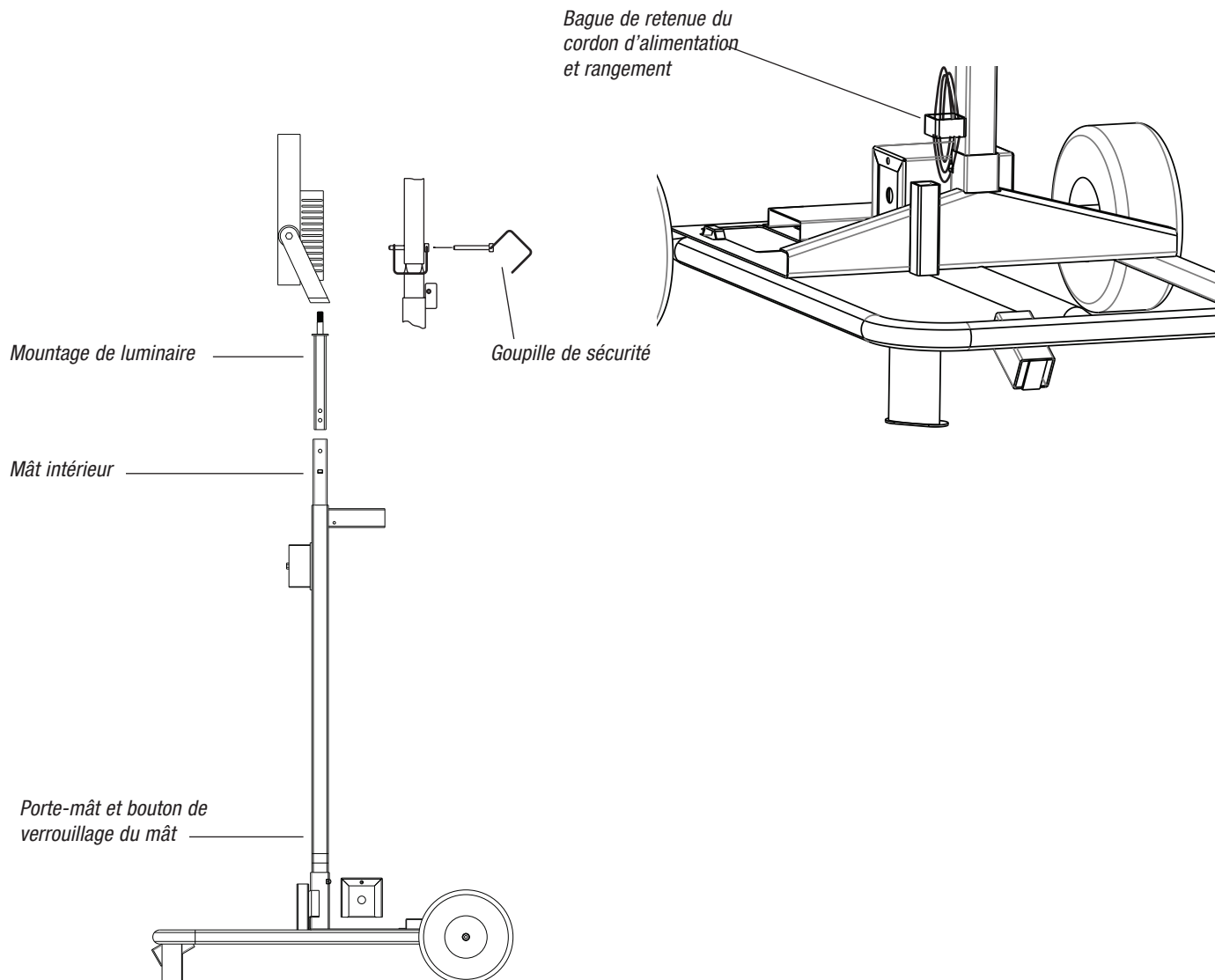

INSTRUCTIONS DE FONCTIONNEMENT :

1. Placez la base de la lampe sur une surface plane stable et réglez le frein de la roue.
2. Utilisez des sacs de sable ou des ancrages pour stabiliser l'unité pour les applications extérieures.
3. Assurez-vous que le cordon est correctement fixé à la base de la lampe pour éviter tout risque de trébuchement.
4. Branchez la lampe dans un circuit correctement mis à la terre. Utilisez un circuit protégé par GFCI pour une utilisation en extérieur.
5. Réglez la tête d'éclairage de la lampe aux angles souhaités.
6. Allongez avec précaution les têtes d'éclairage à la hauteur maximale. Soyez conscient des lignes électriques en hauteur. Faites attention en contrôlant le mât pour éviter qu'il ne tombe et ne blesse l'utilisateur. Assurez-vous que la languette de verrouillage du mât est en place.
7. Allumez l'interrupteur qui est monté sur la section du mât inférieur.



P11300 PIÈCES DE REMPLACEMENT

P104670 Lampe DEL
avec supports de montage

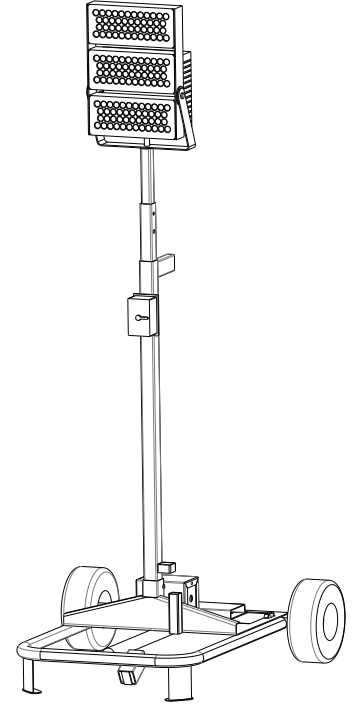
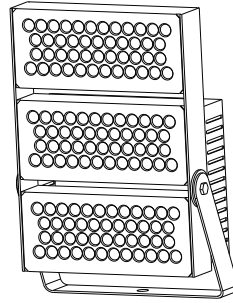

P103615 Boitier de
connexion simple

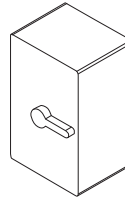

P103616 Couverture
d'interrupteur simple

P103618
Cordon d'alimentation
de 2,2 m (7,5 pi)

P101157
Goupille de blocage

P103593 Base

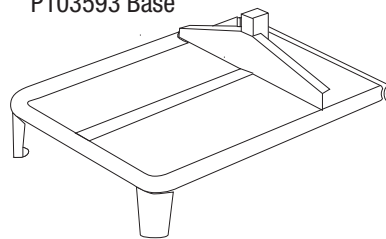

P46052
Bouton 3/8

P40003
Roue

Parties du mât P103606

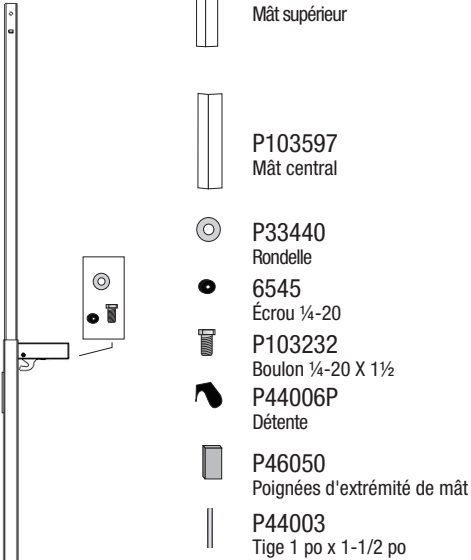

Montage de luminaire

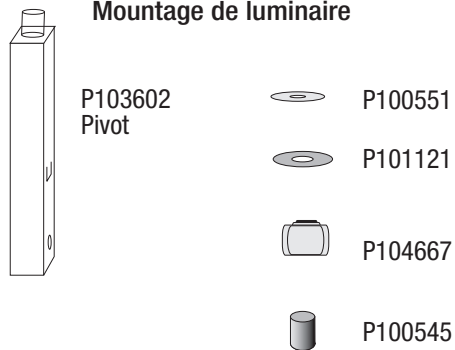

Parties du frein P100436

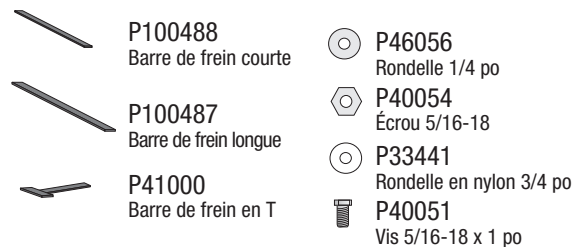

Toutes les vis et rondelles et tous les boulons et écrous sont de tailles standards.



P11600 PIÈCES DE REMPLACEMENT

Parties du mât

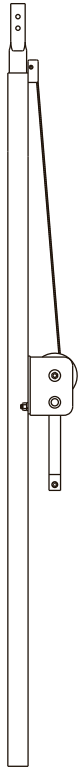

P104670 Lampe DEL
avec supports de montage

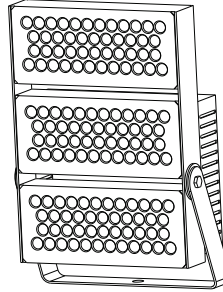

P103769 Boitier de
connexion double

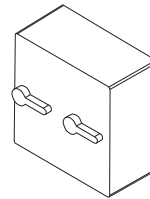

P103770 Couvercle
d'interrupteur double

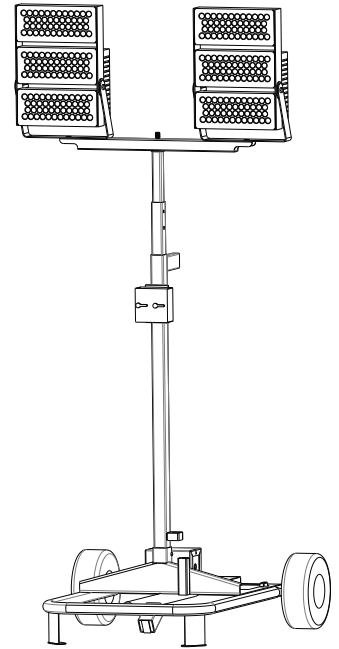

P103618
Cordon d'alimentation
de 2,2 m (7,5 pi)



Assemblage de barre transversale de lampe à double tête

P100512

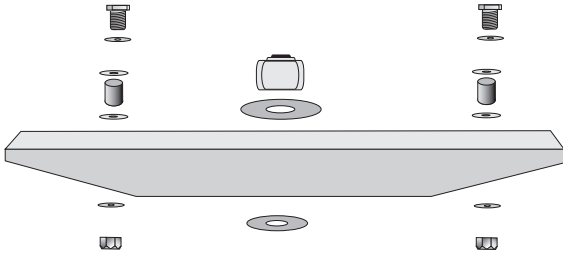

P103593 Base

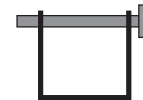
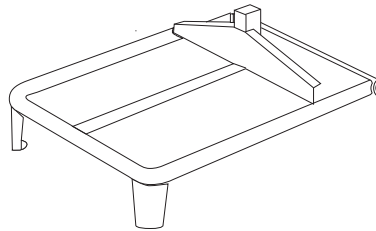

P101157
Goupille de
blocage



P46052
Bouton 3/8



P40003
Roue



P103602
Pivot

- P100551
- P101121
- P104667
- P100545
- P100550

Parties du frein P100436

- P100488
Barre de frein courte
- P100487
Barre de frein longue
- P41000
Barre de frein en T
- P46056
Rondelle 1/4 po
- P40054
Écrou 5/16-18
- P33441
Rondelle en nylon 3/4 po
- P40051
Vis 5/16-18 x 1 po

Toutes les vis et rondelles et tous les boulons et écrous sont de tailles standards.

**CÂBLAGE DU BOITIER DE CONNEXION DE TOUR D'ÉCLAIRAGE
DEL À TÊTE SIMPLE – MODÈLES P11300**

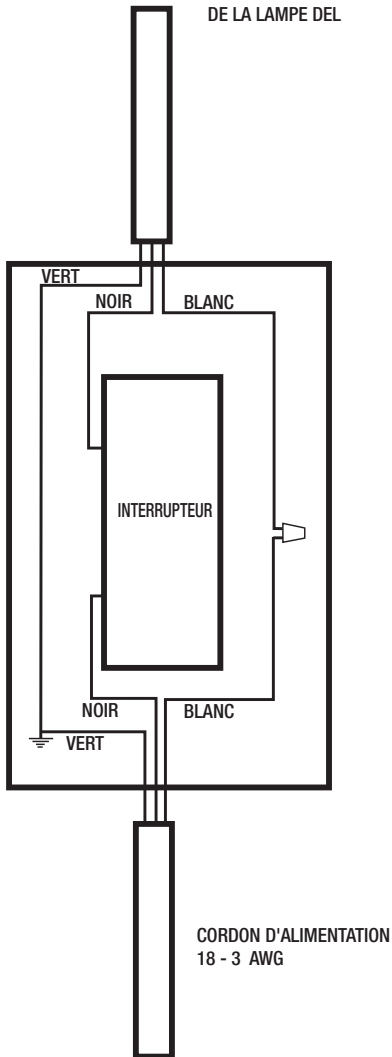

**CÂBLAGE DU BOITIER DE CONNEXION DE TOUR D'ÉCLAIRAGE
DEL À TÊTE DOUBLE – MODÈLES P11600**

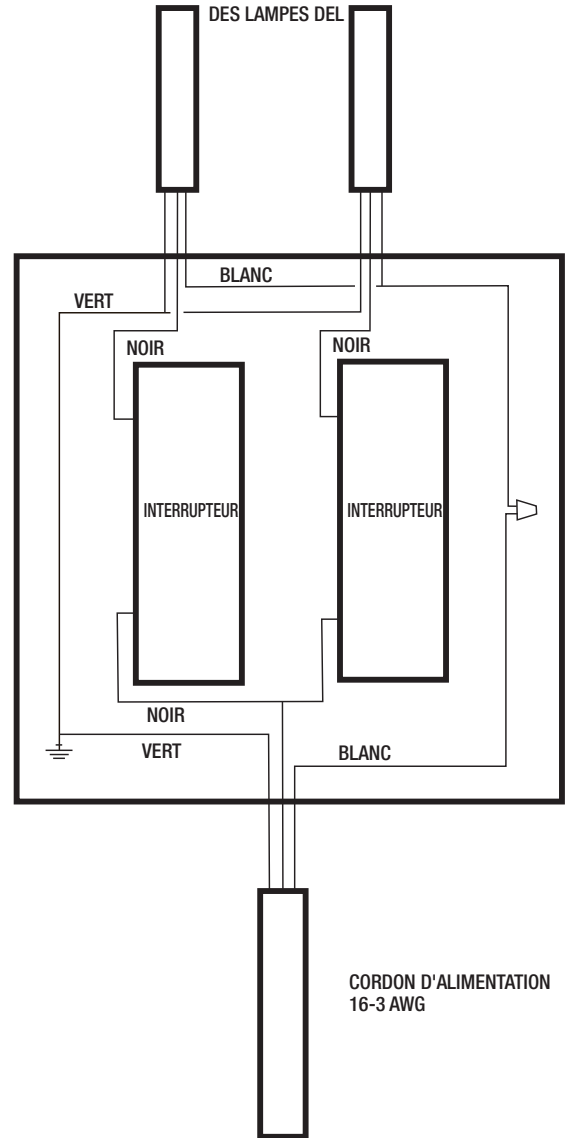

BOÎTE DE JONCTION AVEC INTERRUPTEUR DE BASCULEMENT CÂBLAGE

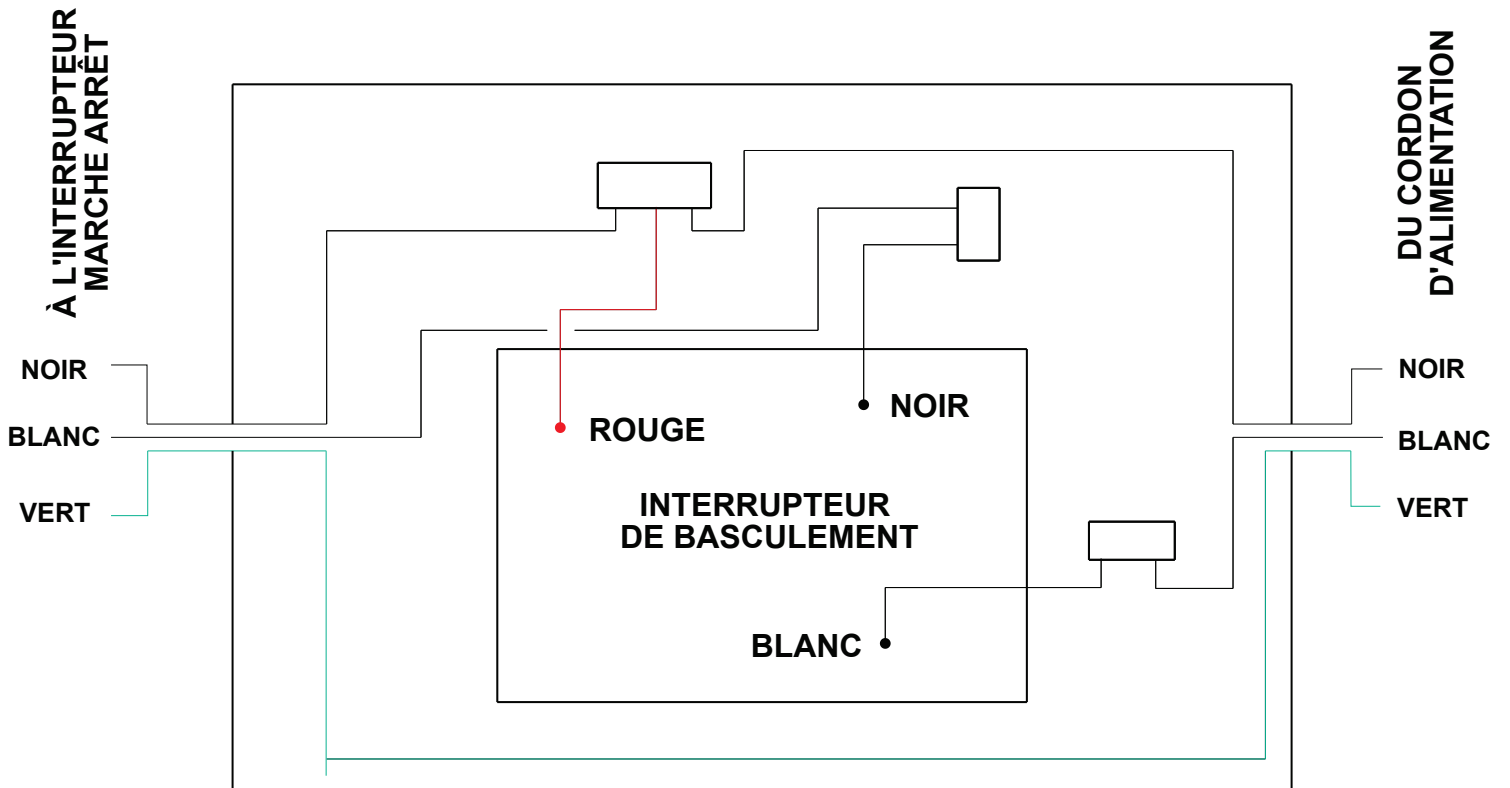

Questions about your light contact:

*Bull Dog Power Products
by Warner Manufacturing
13435 Industrial Park Boulevard
Plymouth, MN 55441 U.S.A.*

Customer service information:

1-800-444-0606

Fax: 1-877-927-6370

*customerservice@warnertool.com
bulldogpower.com
warnertool.com*

**Si desea mayores informes sobre la lámpara,
póngase en contacto con:**

*Bull Dog Power Products
by Warner Manufacturing
13435 Industrial Park Boulevard
Plymouth, MN 55441 EE.UU.*

Información de servicio al cliente:

1-800-444-0606

Fax: 1-877-927-6370

*customerservice@warnertool.com
bulldogpower.com
warnertool.com*

Adresser toute question relative à l'appareil à :

*Bull Dog Power Products
by Warner Manufacturing
13435 Industrial Park Boulevard
Plymouth, MN 55441 ETATS-UNIS*

Service á la clientèle:

1-800-444-0606

Télc. : 1-877-927-6370

*customerservice@warnertool.com
bulldogpower.com
warnertool.com*